





SESAME BODY TYPE P 1"



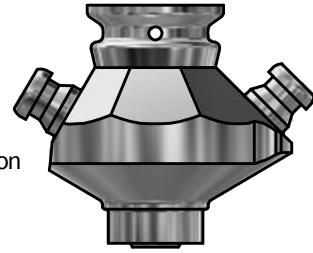

ART. NO. 890011

GENERAL

-  The KEOFITT SESAME Sampling Valve is our patented dual-seat sampling valve. Unique in the market, it eliminates dead-leg during sampling while incorporating steam supply control. Unique serial no. for each valve*.
-  The sampling valve can be used for any process sampling for microbiological, chemical and/or physical analysis.
-  **Cleaning/sterilizing:** Between batches: Valve in open position: Cleanable by means of CIP using the detergent solution suitable for the actual process media. Between samples: Valve in its normal closed position: cleanable by CIP as "Between batches" or the valve may be sterilized by means of steam SIP or chemical SIP using a procedure appropriate to the actual circumstances. For further advice, please contact Keofitt.
-  Designed for sampling of liquids with a viscosity of up to approx. 1.000 cP containing no particles larger than Ø3 mm. Sampling of more viscous liquids is possible, only will it take longer (depending on process pressure).



FEATURES

-  Installation: Pipe welding: DIN EN ISO 1127 25x1.25
-  Operation: Depending on choice of valve head
-  Inlet / Outlet: Hose piece
-  Membrane: Depending on choice of valve head

CERTIFICATION*

· EU EC 1935/2004 · EU EC 2023/2006 · DK No. 1248 10/2018 · 3-A Certificate · 3.1 Material Certificate · Ra Certificate
· ATEX 2014/34/EU · PED 2014/68/EU · Keofitt DoC

TECHNICAL DATA

Material (process contact)

- Steel parts AISI 316L (1.4435 BNII)

Material (without process contact)

- Steel parts AISI 316L (1.4404)

Surface Treatment

- Outside Electropolished Ra ≤ 1.2 µm
- Inside (wetted surface) Electropolished Ra ≤ 0.5 µm
- Process connection Electropolished Ra ≤ 0.5 µm

Pressure & Temperature

- Pressure Depending on choice of valve head
- Temperature Depending on choice of valve head
- Air supply Depending on choice of valve head

Net Weight

- kg/lbs 0.568 kg/1.252 lbs

Spareparts

- NOT APPLICABLE

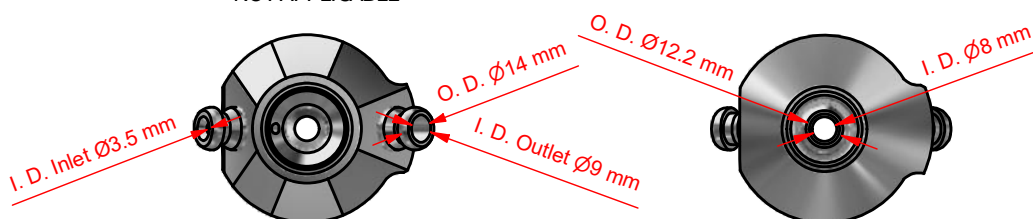
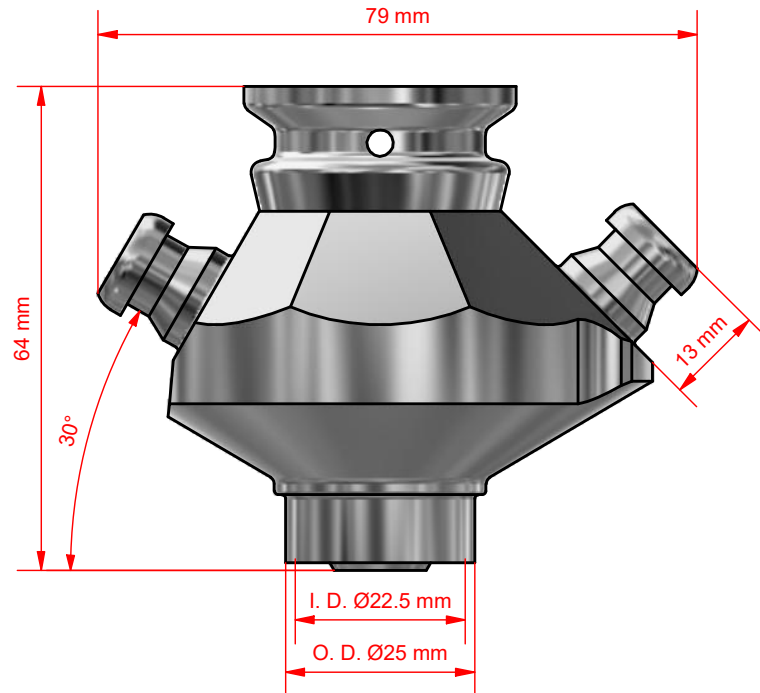









"Patented: DK 175721 B1, CN 100501219C, EP 1 690 038 B1, US 7,658,201 B2"



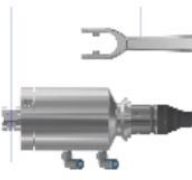



*For further information and download please visit www.keofitt.dk



KEOFITT SESAME VALVE - HEADS

SESAME HEADS			
	TYPE H TURN KNOB 0-10 BAR	TYPE Q LEVER HANDLE 0-10 BAR	TYPE N PNEUMATIC 0-10 BAR
SILICONE	 890041	 890043	 890044
EPDM	 890041E	 890043E	 890044E
PTFE	 895541	 895543	 895544

KEOFITT SESAME INGOLD VALVE - HEADS

SESAME INGOLD HEADS			
	TYPE H TURN KNOB 0-10 BAR	TYPE Q LEVER HANDLE 0-10 BAR	TYPE N PNEUMATIC 0-10 BAR
INGOLD I40 PTFE	 893141PTFE	 893143PTFE	 893144PTFE
INGOLD I52 PTFE	 893241PTFE	 893243PTFE	 893244PTFE