

PERFORMANCE  
MADE  
SMARTER

Product manual

**5714**

***Programmable LED indicator***



TEMPERATURE | I.S. INTERFACES | COMMUNICATION INTERFACES | MULTIFUNCTIONAL | ISOLATION | DISPLAY

No. 5714V104-UK

From serial number: 121496001 (A+B)

131077001 (C+D)

**PR**  
electronics

# 6 Product Pillars

## *to meet your every need*

### Individually outstanding, unrivalled in combination

With our innovative, patented technologies, we make signal conditioning smarter and simpler. Our portfolio is composed of six product areas, where we offer a wide range of analog and digital devices covering over a thousand applications in industrial and factory automation. All our products comply with or surpass the highest industry standards, ensuring reliability in even the harshest of environments and have a 5-year warranty for greater peace of mind.



Temperature

Our range of temperature transmitters and sensors provides the highest level of signal integrity from the measurement point to your control system. You can convert industrial process temperature signals to analog, bus or digital communications using a highly reliable point-to-point solution with a fast response time, automatic self-calibration, sensor error detection, low drift, and top EMC performance in any environment.



I.S. Interface

We deliver the safest signals by validating our products against the toughest safety standards. Through our commitment to innovation, we have made pioneering achievements in developing I.S. interfaces with SIL 2 Full Assessment that are both efficient and cost-effective. Our comprehensive range of analog and digital intrinsically safe isolation barriers offers multifunctional inputs and outputs, making PR an easy-to-implement site standard. Our backplanes further simplify large installations and provide seamless integration to standard DCS systems.



Communication

We provide inexpensive, easy-to-use, future-ready communication interfaces that can access your PR installed base of products. All the interfaces are detachable, have a built-in display for readout of process values and diagnostics, and can be configured via push-buttons. Product specific functionality includes communication via Modbus and Bluetooth and remote access using our PR Process Supervisor (PPS) application, available for iOS and Android.



Multifunction

Our unique range of single devices covering multiple applications is easily deployable as your site standard. Having one variant that applies to a broad range of applications can reduce your installation time and training, and greatly simplify spare parts management at your facilities. Our devices are designed for long-term signal accuracy, low power consumption, immunity to electrical noise and simple programming.



Isolation

Our compact, fast, high-quality 6 mm isolators are based on microprocessor technology to provide exceptional performance and EMC-immunity for dedicated applications at a very low total cost of ownership. They can be stacked both vertically and horizontally with no air gap separation between units required.



Display

Our display range is characterized by its flexibility and stability. The devices meet nearly every demand for display readout of process signals, and have universal input and power supply capabilities. They provide a real-time measurement of your process value no matter the industry, and are engineered to provide a user-friendly and reliable relay of information, even in demanding environments.

# Programmable LED indicator 5714

## Table of contents

Warning .....	4
Symbol identification .....	4
Safety instructions .....	4
Front and back layout .....	6
Application .....	7
Technical characteristics .....	7
Mounting .....	7
Applications .....	8
Order .....	9
Electrical specifications .....	9
Sensor error detection / sensor error detection outside range .....	12
Connections .....	14
Block diagram .....	15
Routing diagram .....	17
Scrolling help text .....	18
Configuration / operating the function keys .....	20
Graphic depiction of the relay function setpoint .....	21
Document history .....	22

## Warning



**GENERAL**

This device is designed for connection to hazardous electric voltages. Ignoring this warning can result in severe personal injury or mechanical damage. To avoid the risk of electric shock and fire, the safety instructions of this manual must be observed and the guidelines followed. The specifications must not be exceeded, and the device must only be applied as described in the following. Prior to the commissioning of the device, this manual must be examined carefully. Only qualified personnel (technicians) should install this device. If the equipment is used in a manner not specified by the manufacturer, the protection provided by the equipment may be impaired.

## Warning



**HAZARDOUS  
VOLTAGE**

Until the device is fixed, do not connect hazardous voltages to the device. The following operations should only be carried out on a disconnected device and under ESD-safe conditions:  
Troubleshooting the device.

**Repair of the device must be done by PR electronics A/S only.**



## Symbol identification



**Triangle with an exclamation mark:** Read the manual before installation and commissioning of the device in order to avoid incidents that could lead to personal injury or mechanical damage. Warning / demand. Potentially lethal situations.



**The CE mark** proves the compliance of the device with the essential requirements of the directives.



**The double insulation symbol** shows that the device is protected by double or reinforced insulation.

## Safety instructions

### Definitions

**Hazardous voltages** have been defined as the ranges: 75 to 1500 Volt DC, and 50 to 1000 Volt AC.

**Technicians** are qualified persons educated or trained to mount, operate, and also trouble-shoot technically correct and in accordance with safety regulations.

**Operators**, being familiar with the contents of this manual, adjust and operate the knobs or potentiometers during normal operation.

### Receipt and unpacking

Unpack the device without damaging it and check whether the device type corresponds to the one ordered. The packing should always follow the device until this has been permanently mounted.

## Environment

Avoid direct sun light, dust, high temperatures, mechanical vibrations and shock, and rain and heavy moisture. If necessary, heating in excess of the stated limits for ambient temperatures should be avoided by way of ventilation.

All devices fall under Installation Category II, Pollution Degree 2, and Insulation Class II.

## Mounting

Only technicians, who are familiar with the technical terms, warnings, and instructions in the manual and who are able to follow these, should connect the device. Should there be any doubt as to the correct handling of the device, please contact your local distributor or, alternatively,

**PR electronics A/S**  
**www.prelectronics.com**

Mounting and connection of the device should comply with national legislation for mounting of electric materials, i.e. wire cross section, protective fuse, and location. Descriptions of input / output and supply connections are shown in the block diagram and side label.

The following apply to fixed hazardous voltages-connected devices:

The max. size of the protective fuse is 10 A and, together with a power switch, it should be easily accessible and close to the device. The power switch should be marked with a label telling it will switch off the voltage to the device.

Year of manufacture can be taken from the first two digits in the serial number.

## UL installation requirements

For use on a flat surface of a type 1 enclosure

Use 60/75°C copper conductors only

Enclosure rating (face only) acc. to UL50E. . . . . Type 4X

Max. ambient temperature . . . . . 60°C

Max. wire size, pins 41...46. . . . . AWG 30-16

Max. wire size, others . . . . . AWG 30-12

UL file number . . . . . E248256

### Relay outputs:

Max. voltage . . . . . 250 VRMS

Max. current. . . . . 2 A / AC

Max. AC power . . . . . 500 VA

Max. current at 24 VDC . . . . . 1 A

## Calibration and adjustment

During calibration and adjustment, the measuring and connection of external voltages must be carried out according to the specifications of this manual. The technician must use tools and instruments that are safe to use.

## Normal operation

Operators are only allowed to adjust and operate devices that are safely fixed in panels, etc., thus avoiding the danger of personal injury and damage. This means there is no electrical shock hazard, and the device is easily accessible.

## Cleaning

When disconnected, the device may be cleaned with a cloth moistened with distilled water.

## Liability

To the extent the instructions in this manual are not strictly observed, the customer cannot advance a demand against PR electronics A/S that would otherwise exist according to the concluded sales agreement.

## Front and back layout



Picture 1: Front of 5714.

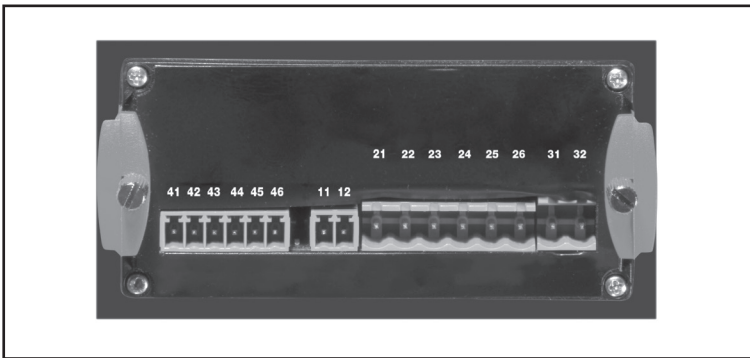

Picture 2: Back of 5714.

# Programmable LED indicator 5714

- 4-digit 14-segment LED indicator
- Input for mA, V, potentiometer, Ohm, RTD and TC
- 2 relays and analog output
- Universal voltage supply
- Front key programmable

## Application

- Display for digital readout of current, voltage, resistance, temperature or potentiometer signals.
- Process control with 2 pairs of potential-free relays and / or analogue output.
- For local readout in extremely wet atmospheres with a specially designed splash-proof cover.

## Technical characteristics

- 4-digit LED indicator with 13.8 mm 14-segment characters. Max. display readout -1999...9999 with programmable decimal point, relay ON / OFF indication.
- All operational parameters can be adjusted to any application by use of the front keys.
- 5714 is available fully-configured acc. to specifications ready for process control and visualisation.
- Help texts in eight languages can be selected via a menu item.
- Inputs, outputs, and supply are floating and galvanically separated.
- In versions with relay outputs the user can minimise the installation test time by activating / deactivating each relay independently of the input signal.

## Mounting

- To be mounted in front panel. The included rubber packing must be mounted between the panel cutout hole and the display front to obtain a protection degree of IP65 (type 4X). For extra protection in extreme environments, 5714 can be delivered with a specially designed splash-proof cover as accessory.

# Applications

## Input signals:

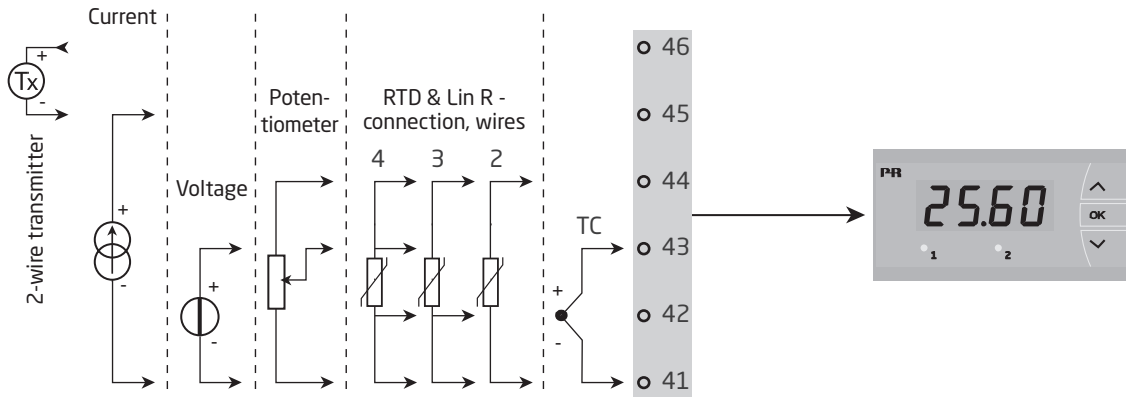

## Output signals:

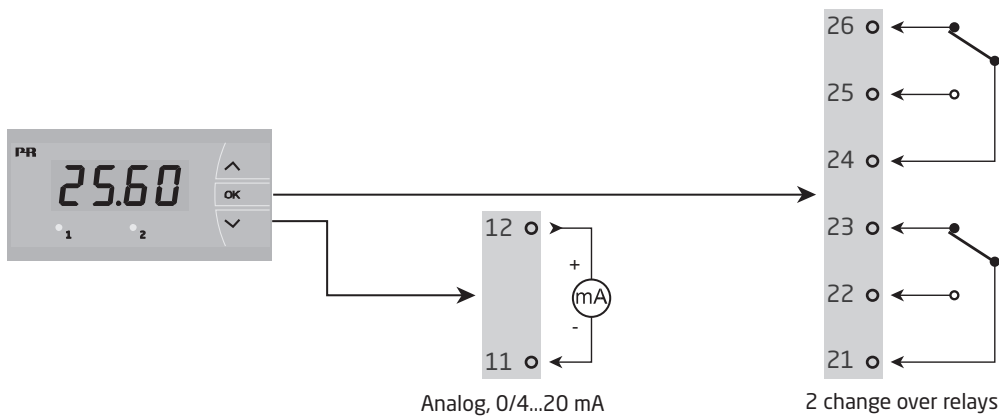

## Supply:

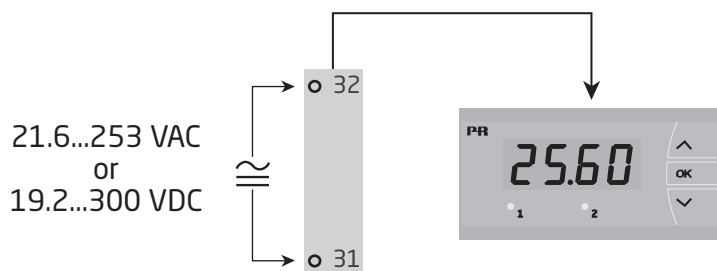



## Order

Type	Version
<b>5714</b>	Standard : A
	2 relays : B
	Analog output : C
	Analog output and 2 relays : D

NB! Please order the splash-proof cover separately. Order No. 8335.

## Electrical specifications

### Environmental conditions:

Ambient operating temperature range . . . . .	-20°C to +60°C
Calibration temperature. . . . .	20...28°C
Humidity. . . . .	< 95% RH (non-cond.)
Protection degree (mounted in panel) . . . . .	IP65 / Type 4X

### Mechanical specifications:

Dimensions (HxWxD) . . . . .	48 x 96 x 120 mm
Cutout dimensions. . . . .	44.5 x 91.5 mm
Weight . . . . .	230 g
Wire size, pin 41...46 max. . . . .	0.05...1.31 mm <sup>2</sup> AWG 30...16 stranded wire
Wire size, others max. . . . .	0.05...3.31 mm <sup>2</sup> / AWG 30...12 stranded wire
Vibration. . . . .	IEC 60068-2-6
2...13.2 Hz . . . . .	±1 mm
13.2...100 Hz. . . . .	±0.7 g

### Common specifications:

Supply voltage, universal. . . . .	21.6...253 VAC, 50...60 Hz or 19.2...300 VDC
------------------------------------	---

Type	Internal power dissipation	Max. required power
<b>5714A</b>	2.2 W	2.5 W
<b>5714B/C</b>	2.7 W	3.0 W
<b>5714D</b>	3.2 W	3.5 W

Isolation voltage, test / operation. . . . .	2.3 kVAC / 250 VAC
Signal- / noise ratio . . . . .	Min. 60 dB (0...100 kHz)
Response time (0...90 %, 100...10 %), programmable:	
Temperature input. . . . .	1...60 s
Current / voltage input . . . . .	0.4...60

Accuracy, the greater of the general and basic values:

General values		
Input type	Absolute accuracy	Temperature coefficient
All	≤ ±0.1% of reading	≤ ±0.01% of reading / °C

Basic values		
Input type	Basic accuracy	Temperature coefficient
mA	$\leq \pm 4 \mu\text{A}$	$\leq \pm 0.4 \mu\text{A} / ^\circ\text{C}$
Volt	$\leq \pm 20 \mu\text{V}$	$\leq \pm 2 \mu\text{V} / ^\circ\text{C}$
Pt100	$\leq \pm 0.2^\circ\text{C}$	$\leq \pm 0.01^\circ\text{C} / ^\circ\text{C}$
Linear resistance	$\leq \pm 0.1^\circ\Omega$	$\leq \pm 0.01 \Omega / ^\circ\text{C}$
Potentiometer	$\leq \pm 0.1^\circ\Omega$	$\leq \pm 0.01 \Omega / ^\circ\text{C}$
TC type: E, J, K, L, N, T, U	$\leq \pm 1^\circ\text{C}$	$\leq \pm 0.05^\circ\text{C} / ^\circ\text{C}$
TC type: R, S, W3, W5, LR	$\leq \pm 2^\circ\text{C}$	$\leq \pm 0.2^\circ\text{C} / ^\circ\text{C}$
TC type: B 85...200°C	$\leq \pm 4^\circ\text{C}$	$\leq \pm 0.4^\circ\text{C} / ^\circ\text{C}$
TC type: B 200...1820°C	$\leq \pm 2^\circ\text{C}$	$\leq \pm 0.2^\circ\text{C} / ^\circ\text{C}$

EMC - immunity influence. . . . .  $< \pm 0.5\%$  of readout

Auxiliary supply:

2 wire supply, pin 46...45. . . . . 25...15 VDC / 0...20 mA

**TC input**

Type	Min. value	Max. value	Standard
B	0°C	+1820°C	IEC 60584-1
E	-100°C	+1000°C	IEC 60584-1
J	-100°C	+1200°C	IEC 60584-1
K	-180°C	+1372°C	IEC 60584-1
L	-200°C	+900°C	DIN 43710
N	-180°C	+1300°C	IEC 60584-1
R	-50°C	+1760°C	IEC 60584-1
S	-50°C	+1760°C	IEC 60584-1
T	-200°C	+400°C	IEC 60584-1
U	-200°C	+600°C	DIN 43710
W3	0°C	+2300°C	ASTM E988-90
W5	0°C	+2300°C	ASTM E988-90
LR	-200°C	+800°C	GOST 3044-84

Cold junction compensation (CJC) via internal sensor . . . . .  $\pm(2.0^\circ\text{C} + 0.4^\circ\text{C} * \Delta t)$

$\Delta t$  = internal temperature - ambient temperature

Sensor error detection, all TC types. . . . . Yes

Sensor error current:

when detecting . . . . . Nom. 2  $\mu\text{A}$

else. . . . . 0  $\mu\text{A}$

## RTD, linear resistance and potentiometer input

Input type	Min. value	Max. value	Standard
Pt10...Pt1000	-200°C	+850°C	IEC 60751
Ni50...Ni1000	-60°C	+250°C	DIN 43760
Cu10...Cu100	-200°C	+260°C	$\alpha = 0.00427$
Lin. R	0 $\Omega$	10000 $\Omega$	-
Potentiometer	10 $\Omega$	100 k $\Omega$	-

Input for RTD types:

Pt10, Pt20, Pt50, Pt100, Pt200, PT250, Pt300, Pt400, Pt500, Pt1000

Ni50, Ni100, Ni120, Ni1000, Cu10, Cu20, Cu50, Cu100

Cable resistance pr. wire, RTD (max.) . . . . . 50  $\Omega$

Sensor current, RTD . . . . . Nom. 0.2 mA

Effect of sensor cable resistance (3- / 4-wire), RTD . . . . . < 0.002  $\Omega$  /  $\Omega$

Sensor error detection, RTD . . . . . Yes

Short circuit detection, RTD . . . . . < 15  $\Omega$

### Current input

Measurement range . . . . . 0...23 mA

Programmable measurement ranges . . . . . 0...20 and 4...20 mA

Input resistance . . . . . Nom. 20  $\Omega$  + PTC 25  $\Omega$

Sensor error detection:

loop break 4...20 mA . . . . . Yes

### Voltage input

Measurement range . . . . . 0...12 VDC

Programmable measurement ranges . . . . . 0...1 / 0.2...1 / 0...10 / 2...10 VDC

Input resistance . . . . . Nom. 10 M $\Omega$

### Outputs

#### Display

Display readout . . . . . -1999...9999 (4 digits)

Decimal point . . . . . Programmable

Digit height . . . . . 13.8 mm

Display updating . . . . . 2.2 times / s

Input outside input range is indicated by . . . . . Explanatory text

#### Current output

Signal range (span) . . . . . 0...23 mA

Programmable signal ranges . . . . . 0...20 / 4...20 / 20...0 / 20...4 mA

Load (max.) . . . . .  $\leq$  800  $\Omega$

Load stability . . . . .  $\leq$  0.01% of span / 100  $\Omega$

Sensor error detection . . . . . 0 / 3.5 / 23 mA / none

NAMUR NE 43 up / downscale . . . . . 23 mA / 3.5 mA

Output limitation:

on 4...20 and 20...4 mA signals . . . . . 3,8...20.5 mA

on 0...20 and 20...0 mA signals . . . . . 0...20.5 mA

Current limit. . . . .  $\leq$  28 mA

## Relay outputs

Relay function . . . . .	Setpoint
Hysteresis. . . . .	0...100%
On and Off delay . . . . .	0...3600 s
Sensor error detection . . . . .	Make / Break / Hold
Max. voltage . . . . .	250 VAC / VDC
Max. AC current. . . . .	2 A
Max. AC power . . . . .	500 VA
Max. DC current, resistive load:	
@ $U_{\text{relay}} \leq 30$ VDC . . . . .	2 ADC
@ $U_{\text{relay}} > 30$ VDC. . . . .	$[1380 \times U_{\text{relay}}^{-2} \times 1.0085^{U_{\text{relay}}}]$ ADC

Graphic depiction of  $[1380 \times U_{\text{relay}}^{-2} \times 1.0085^{U_{\text{relay}}}]$ :

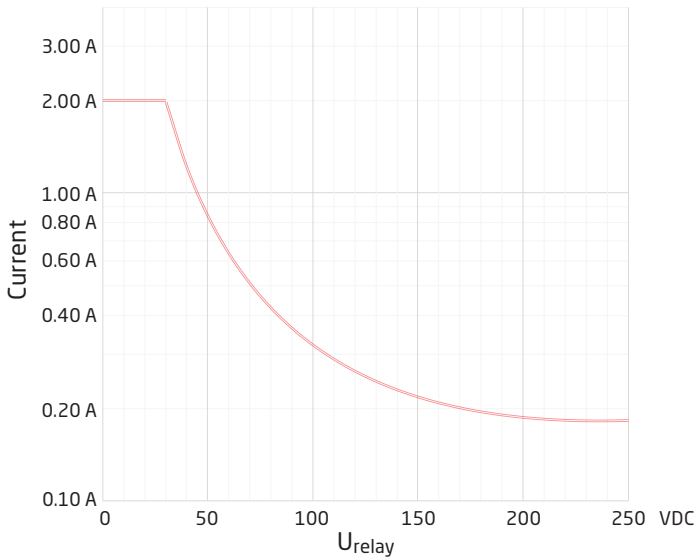

## Observed authority requirements

EMC. . . . .	2014/30/EU
LVD . . . . .	2014/35/EU
RoHS . . . . .	2011/65/EU
UL, Standard for Safety . . . . .	UL 508
EAC . . . . .	TR-CU 020/2011

## Approvals

EU RO Mutual Recognition Type Approval . . . . .	MRA000000Z
DNV-GL, Ships & Offshore . . . . .	Standard for Certification No. 2.4

## Sensor error detection / sensor error detection outside range

Sensor error check in 5714 variants		
Variant	Configuration	Sensor error detection
5714A	Always:	ON
5714B	ERR1=NONE, ERR2=NONE:	OFF
	else:	ON
5714C	O.ERR=NONE:	OFF
	else:	ON
5714D	ERR1=NONE, ERR2=NONE, O.ERR=NONE:	OFF
	else:	ON

<b>Outside range readout (IN.LO, IN.HI): If the valid range of the A/D converter or the polynomial is exceeded</b>			
<b>Input</b>	<b>Range</b>	<b>Readout</b>	<b>Limit</b>
VOLT	0...1 V / 0.2...1 V	IN.LO	< -25 mV
		IN.HI	> 1.2 V
	0...10 V / 2...10 V	IN.LO	< -25 mV
		IN.HI	> 12 V
CURR	0...20 mA / 4...20 mA	IN.LO	< -1.05 mA
		IN.HI	> 25.05 mA
POTM	-	IN.LO	< -0.5%
		IN.HI	> 100.5%
TEMP	TC / RTD	IN.LO	< temperature range -2°C
		IN.HI	> temperature range +2°C
LIN. R	0...800 ohm	IN.LO	< 0 ohm
		IN.HI	> 1 kohm
	0...10 kohm	IN.LO	< 0 ohm
		IN.HI	> 15 kohm

<b>Sensor error detection (SE.BR, SE.SH)</b>			
<b>Input</b>	<b>Range</b>	<b>Readout</b>	<b>Limit</b>
CURR	Loop break (4...20 mA)	SE.BR	<= 3.6 mA; > = 21 mA
TEMP	TC	SE.BR	> ca. 750 kohm / (1.25 V)
	RTD, 2-, 3- & 4-wire No SE.SH for Cuxx, Pt10, Pt20 & Pt50-	SE.BR	> 12 kohm
		SE.SH	< 15 ohm
LIN. R	0...800 ohm	SE.BR	> 875 ohm
	0...10 kohm	SE.BR	> 12 kohm

<b>Display readout below min. / above max. (-1.9.9.9, 9.9.9.9)</b>			
<b>Input</b>	<b>Range</b>	<b>Readout</b>	<b>Limit</b>
CURR VOLT	All	-1.9.9.9	Display readout <-1999
		9.9.9.9	Display readout >9999
LIN. R	All	-1.9.9.9	Display readout <-1999
		9.9.9.9	Display readout >9999
POTM	-	-1.9.9.9	Display readout <-1999
		9.9.9.9	Display readout >9999

<b>Readout at hardware error</b>		
<b>Error search</b>	<b>Readout</b>	<b>Cause</b>
Test of internal communication $\mu$ C / ADC	HW.ER	Permanent error in ADC
Test of internal CJC sensor	CJ.ER	CJC sensor defect
Check-sum test of the configuration in RAM	RA.ER	Error in RAM
Check-sum test of the configuration in EEPROM	EE.ER	Error in EEPROM

! Error indications in the display blink once a second. The help text explains the error.

# Connections

## Inputs:

RTD & Lin R, 2-wire

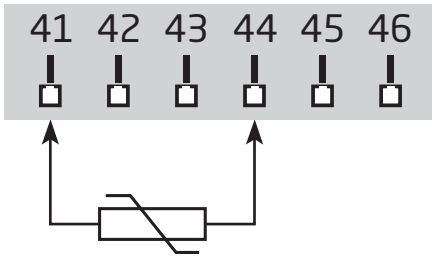

RTD & Lin R, 3-wire

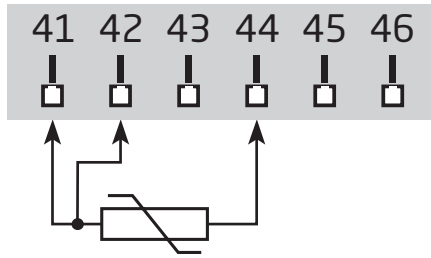

RTD & Lin R, 4-wire

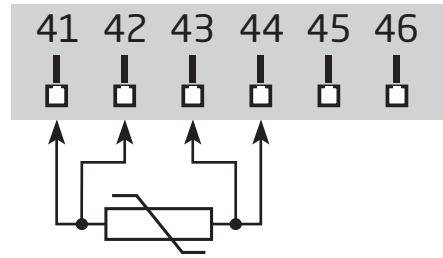

TC

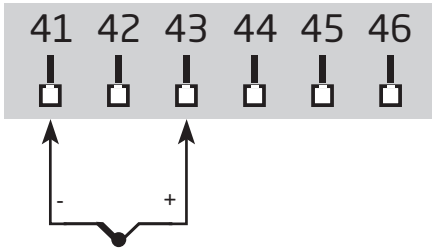

2-wire transmitter

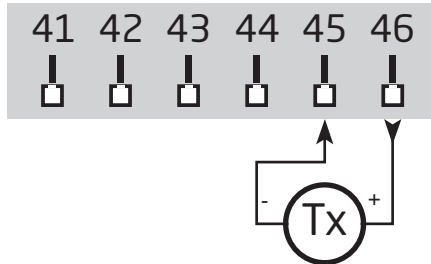

Current

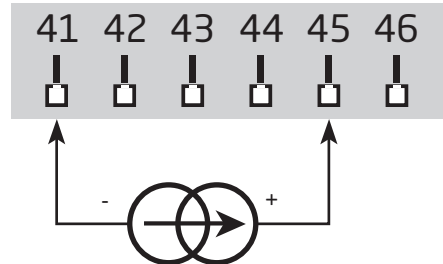

Voltage

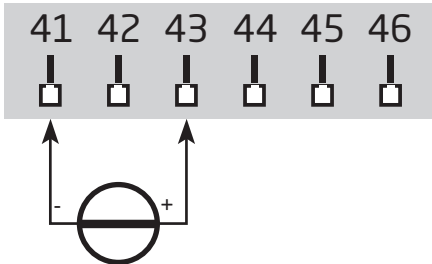

Potentiometer

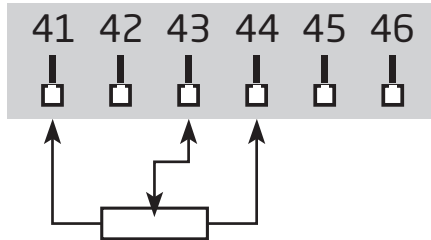

## Output:

### Supply:

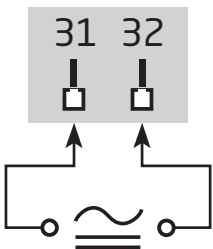

Current

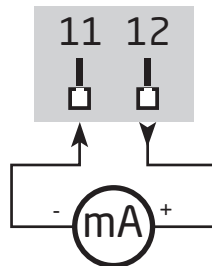

Relays

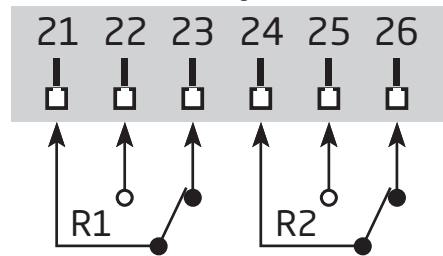







# Routing diagram

If no keys are activated for 2 minutes the display returns to default state 1.0 without saving configuration changes.

⬆ Increase value / choose next parameter.

⬇ Decrease value / choose previous parameter.

⊗ Accept the chosen parameter and go to the next menu.

Hold ⊗ Back to previous menu / return to menu 1.0 without saving.

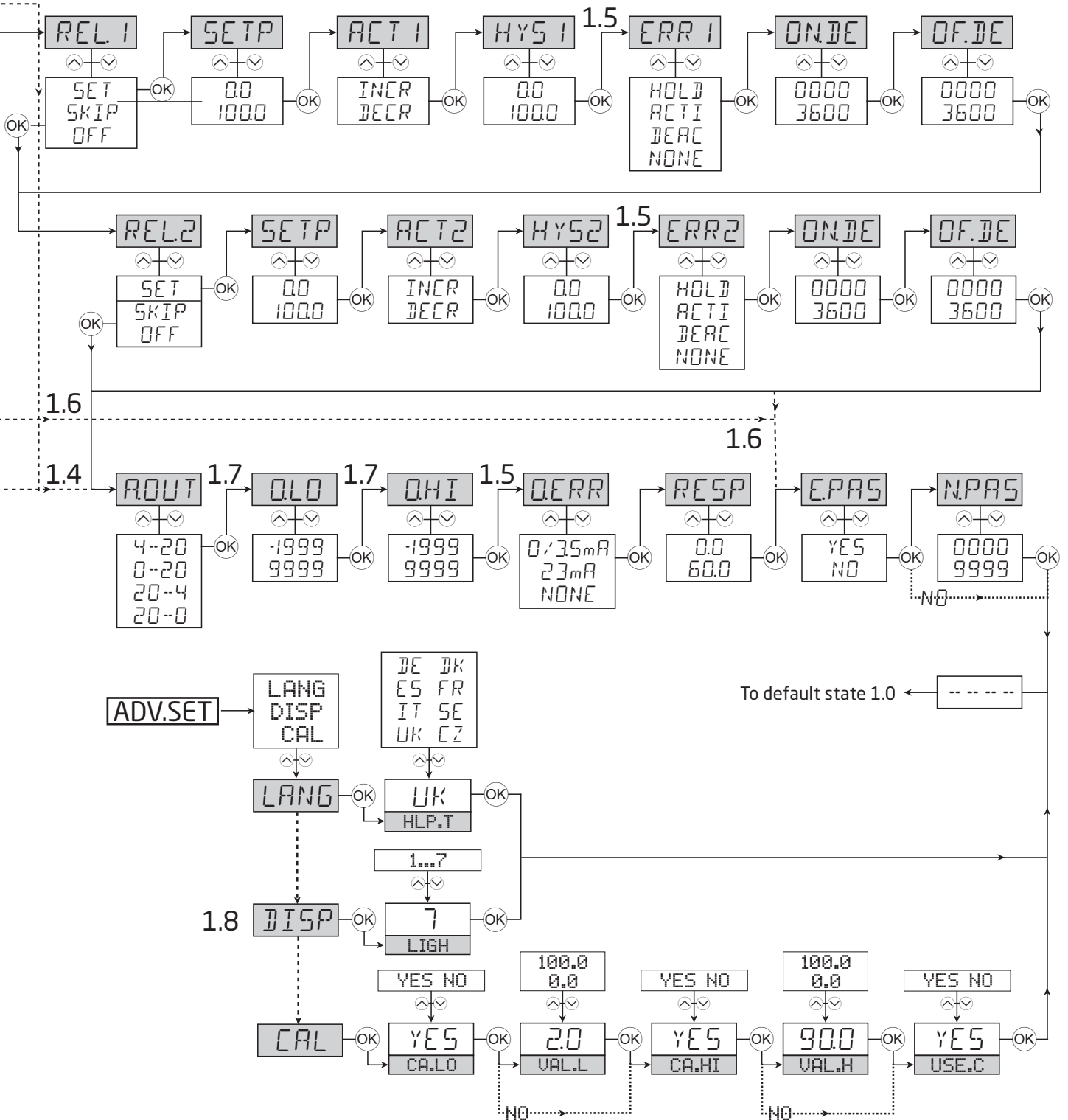

## Scrolling help text

### Display in default state xxxx, hardware error:

**SE.BR** --> SENSOR WIRE BREAKAGE  
**SE.SH** --> SENSOR SHORT CIRCUIT  
**IN.HI** --> INPUT OVERRANGE  
**IN.LO** --> INPUT UNDERRANGE  
**9.9.9.9** --> DISPLAY OVERRANGE  
**-1.9.9.9** --> DISPLAY UNDERRANGE  
**HW.ER** --> HARDWARE ERROR  
**EE.ER** --> EEPROM ERROR - CHECK CONFIGURATION  
**RA.ER** --> RAM MEMORY ERROR  
**CJ.ER** --> CJC SENSOR ERROR

### Fastset (Enabled):

**F.SET**  
**REL1** --> FAST SET MENU -  
**REL2** --> SELECT RELAY  
  
**SETP**  
 xxxx --> RELAY SETPOINT - PRESS OK TO SAVE

### Fastset (Disabled):

**SETP**  
 xxxx --> RELAY SETPOINT - READ ONLY

### Configuration menus:

**ADV**  
**YES** --> ENTER ADVANCED SETUP MENU?  
**NO**

**PASS**  
 xxxx --> SET CORRECT PASSWORD

**IN**  
**C.LIN\*** --> TEXT ENTERED BY USER IN PRESET  
**CURR** --> CURRENT INPUT  
**VOLT** --> VOLTAGE INPUT  
**POTM** --> POTENTIOMETER INPUT  
**LIN.R** --> LINEAR RESISTANCE INPUT  
**TEMP** --> TEMPERATURE SENSOR INPUT

### RANG When current selected:

0-20 --> INPUT RANGE IN mA  
 4-20 --> INPUT RANGE IN mA

### RANG When voltage selected:

0-10 --> INPUT RANGE IN VOLT  
 2-10 --> INPUT RANGE IN VOLT  
 0.0-1 --> INPUT RANGE IN VOLT  
 0.2-1 --> INPUT RANGE IN VOLT

### DEC.P

1111 --> DECIMAL POINT POSITION  
 111.1 --> DECIMAL POINT POSITION  
 11.11 --> DECIMAL POINT POSITION  
 1.111 --> DECIMAL POINT POSITION

### LR.LO

xxxx --> SET RESISTANCE VALUE LOW

### LR.HI

xxxx --> SET RESISTANCE VALUE HIGH

### DI.LO

xxxx --> DISPLAY READOUT LOW

### DI.HI

xxxx --> DISPLAY READOUT HIGH

### REL.U

PERC --> SET RELAY IN PERCENTAGE  
 DISP --> SET RELAY IN DISPLAY UNITS

### TYPE

CU --> SELECT CU SENSOR TYPE  
 PT --> SELECT PT SENSOR TYPE  
 NI --> SELECT NI SENSOR TYPE  
 TC --> SELECT TC SENSOR TYPE

### CU.TY

10 --> SELECT CU SENSOR TYPE  
 20 --> SELECT CU SENSOR TYPE  
 50 --> SELECT CU SENSOR TYPE  
 100 --> SELECT CU SENSOR TYPE

### PT.TY

10 --> SELECT PT SENSOR TYPE  
 20 --> SELECT PT SENSOR TYPE  
 50 --> SELECT PT SENSOR TYPE  
 100 --> SELECT PT SENSOR TYPE  
 200 --> SELECT PT SENSOR TYPE  
 250 --> SELECT PT SENSOR TYPE  
 300 --> SELECT PT SENSOR TYPE  
 400 --> SELECT PT SENSOR TYPE  
 500 --> SELECT PT SENSOR TYPE  
 1000 --> SELECT PT SENSOR TYPE

### NI.TY

50 --> SELECT NI SENSOR TYPE  
 100 --> SELECT NI SENSOR TYPE  
 120 --> SELECT NI SENSOR TYPE  
 1000 --> SELECT NI SENSOR TYPE

### CONN

When Cu, Pt and Ni sensor is selected  
 2W --> SELECT 2-WIRE SENSOR CONNECTION  
 3W --> SELECT 3-WIRE SENSOR CONNECTION  
 4W --> SELECT 4-WIRE SENSOR CONNECTION

### TC.TY

TC. B --> SELECT TC SENSOR TYPE  
 TC. E --> SELECT TC SENSOR TYPE  
 TC. J --> SELECT TC SENSOR TYPE  
 TC. K --> SELECT TC SENSOR TYPE  
 TC. L --> SELECT TC SENSOR TYPE  
 TC. N --> SELECT TC SENSOR TYPE  
 TC. R --> SELECT TC SENSOR TYPE  
 TC. S --> SELECT TC SENSOR TYPE  
 TC. T --> SELECT TC SENSOR TYPE  
 TC. U --> SELECT TC SENSOR TYPE  
 TC.W3 --> SELECT TC SENSOR TYPE  
 TC.W5 --> SELECT TC SENSOR TYPE  
 TC.LR --> SELECT TC SENSOR TYPE

### DEC.P

When temperature selected  
 1111 --> DECIMAL POINT POSITION  
 111.1 --> DECIMAL POINT POSITION

### UNIT

°C --> DISPLAY AND RELAY SETUP IN CELSIUS  
 °F --> DISPLAY AND RELAY SETUP IN FAHRENHEIT

**REL1**  
 SET --> ENTER RELAY 1 SETUP  
 SKIP --> SKIP RELAY 1 SETUP  
 OFF --> RELAY 1 DISABLED

**SETP**  
 xxxx --> RELAY SETPOINT

**ACT1**  
 INCR --> ACTIVATE AT INCREASING SIGNAL  
 DECR --> ACTIVATE AT DECREASING SIGNAL

**HYS1**  
 xxxx --> RELAY HYSTERESIS

**ERR1**  
 HOLD --> HOLD RELAY AT ERROR  
 ACTI --> ACTIVATE RELAY AT ERROR  
 DEAC --> DEACTIVATE RELAY AT ERROR  
 NONE --> UNDEFINED STATUS AT ERROR

**ON.DE**  
 xxxx --> RELAY ON-DELAY IN SECONDS

**OF.DE**  
 xxxx --> RELAY OFF-DELAY IN SECONDS

**REL2**  
 SET --> ENTER RELAY 2 SETUP  
 SKIP --> SKIP RELAY 2 SETUP  
 OFF --> RELAY 2 DISABLED

**SETP**  
 xxxx --> RELAY SETPOINT

**ACT2**  
 INCR --> ACTIVATE AT INCREASING SIGNAL  
 DECR --> ACTIVATE AT DECREASING SIGNAL

**HYS2**  
 xxxx --> RELAY HYSTERESIS

**ERR2**  
 HOLD --> HOLD RELAY AT ERROR  
 ACTI --> ACTIVATE RELAY AT ERROR  
 DEAC --> DEACTIVATE RELAY AT ERROR  
 NONE --> UNDEFINED STATUS AT ERROR

**ON.DE**  
 xxxx --> RELAY ON-DELAY IN SECONDS

**OF.DE**  
 xxxx --> RELAY OFF-DELAY IN SECONDS

**A.OUT**  
 0-20 --> OUTPUT RANGE IN mA  
 4-20 --> OUTPUT RANGE IN mA  
 20-0 --> OUTPUT RANGE IN mA  
 20-4 --> OUTPUT RANGE IN mA

**O.LO**  
 xxxx --> DISPLAY VALUE FOR OUTPUT LOW

**O.HI**  
 xxxx --> DISPLAY VALUE FOR OUTPUT HIGH

**O.ERR**  
 23 mA --> NAMUR NE43 UPSCALE AT ERROR  
 3,5 mA --> NAMUR NE43 DOWNSCALE AT ERROR  
 0mA --> DOWNSCALE AT ERROR  
 NONE --> UNDEFINED OUTPUT AT ERROR

**RESP**  
 xxx.x --> ANALOGUE OUTPUT RESPONSE TIME IN SECONDS

**E.PAS**  
 NO --> ENABLE PASSWORD PROTECTION  
 YES

**N.PAS**  
 xxxx --> SELECT NEW PASSWORD

ADV MENU:  
 LANG --> ENTER LANGUAGE SETUP  
 DISP --> ENTER DISPLAY SETUP  
 CAL --> PERFORM PROCESS CALIBRATION

**HLP.T**  
 DE --> DE - WAEHLE DEUTSCHEN HILFETEXT  
 DK --> DK - VAELG DANSK HJAEHPETEKST  
 ES --> ES - SELECCIONAR TEXTO DE AYUDA EN ESPANOL  
 FR --> FR - SELECTION TEXTE D'AIDE EN FRANCAIS  
 IT --> IT - SELEZIONARE TESTI DI AIUTO ITALIANI  
 SE --> SE - VALJ SVENSK HJALPTEXT  
 UK --> UK - SELECT ENGLISH HELPTTEXT  
 CZ --> CZ - VYBER CESKOU NAPOVEDU

**LIGH**  
 xxxx --> ADJUST DISPLAY LIGHT INTENSITY

**CA.LO**  
 YES --> CALIBRATE INPUT LOW TO PROCESS VALUE?  
 NO

**CA.HI**  
 YES --> CALIBRATE INPUT HIGH TO PROCESS VALUE?  
 NO

**VAL.L**  
 xxxx --> SET VALUE FOR LOW CALIBRATION POINT

**VAL.H**  
 xxxx --> SET VALUE FOR HIGH CALIBRATION POINT

**USE.C**  
 YES --> USE PROCESS CALIBRATED VALUES?  
 NO

# Configuration / operating the function keys

Documentation for routing diagram.

## In general

When configuring the display you are guided through all parameters, you can choose the settings which fit the application. For each menu there is a scrolling help text which is automatically shown in the display, this starts after 5 seconds if no key has been activated.

Configuration is carried out by using the 3 function keys.

- ⏪ will increase the numerical value or choose the next parameter.
- ⏩ will decrease the numerical value or choose the previous parameter.
- ⏹ will accept the chosen value and end the menu.

If a function does not exist in the display all parameters are skipped to make the configuration as simple as possible. Once the configuration has been entered the display will show "----".

Pressing and holding ⏹ will return to the previous menu or return to the default state (1.0) without saving the changed values or parameters.

If no key is activated for 2 minutes, the display will return to the default state (1.0) without saving the changed values or parameters.

## Further explanations

**Fast setpoint adjustment and relay test:** These menus allow you to change the set point quickly and to check the operation of the relays.

Pressing ⏪ and ⏩ at the same time will change the state of the relay - this change is indicated by the diodes on the display.

Pressing ⏹ will save the set point change.

Holding down ⏹ for more than 0.5 seconds will return the unit to the default state without changing the set point.

**Password protection:** Using a password will stop access to the menu and parameters. There are two levels of password protection. Passwords between 0000...4999 allow access to the fast set point adjustment and relay test. (Using this password stops access to all other parts of the menu). Passwords between 5000...9999 stop access to all parts of the menu, fast set point and relay test. (Current set point is still shown). By using the master password 2008, all configuration menus are available.

# Graphic depiction of the relay function setpoint

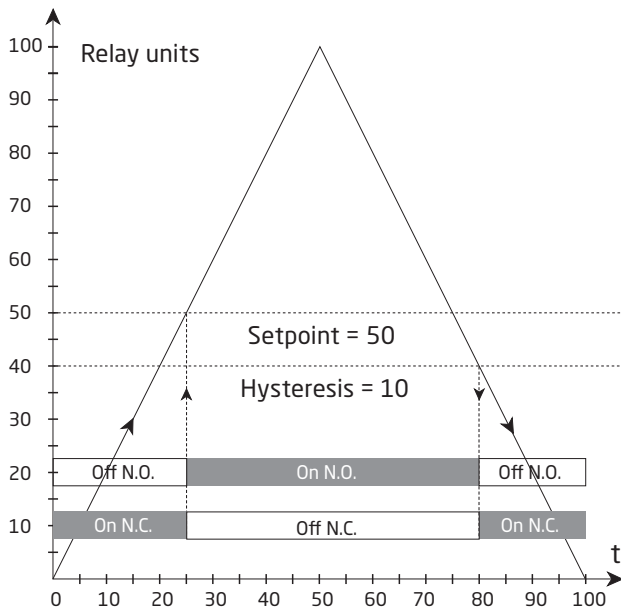

Relay action: Increasing

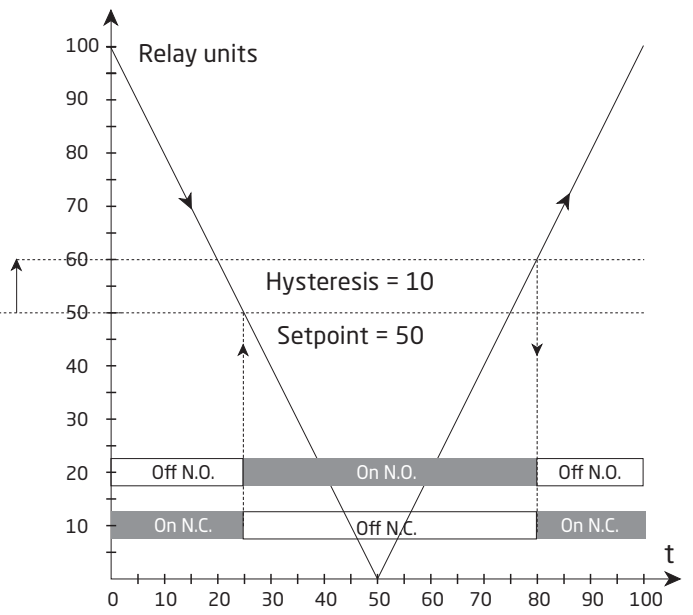

Relay action: Decreasing

## Document history

The following list provides notes concerning revisions of this document.

<b>Rev. ID</b>	<b>Date</b>	<b>Notes</b>
104	19/33	Relay data updated, graph with resistive loads inserted. EU-RO marine approval added.

# We are near you, *all over the world*

**Our trusted red boxes are supported wherever you are**

All our devices are backed by expert service and a 5-year warranty. With each product you purchase, you receive personal technical support and guidance, day-to-day delivery, repair without charge within the warranty period and easily accessible documentation.

We are headquartered in Denmark, and have offices and authorized partners the world over. We are a local

business with a global reach. This means that we are always nearby and know your local markets well. We are committed to your satisfaction and provide PERFORMANCE MADE SMARTER all around the world.

For more information on our warranty program, or to meet with a sales representative in your region, visit [prelectronics.com](http://prelectronics.com).

# Benefit today from *PERFORMANCE MADE SMARTER*

PR electronics is the leading technology company specialized in making industrial process control safer, more reliable and more efficient. Since 1974, we have been dedicated to perfecting our core competence of innovating high precision technology with low power consumption. This dedication continues to set new standards for products communicating, monitoring and connecting our customers' process measurement points to their process control systems.

Our innovative, patented technologies are derived from our extensive R&D facilities and from having a great understanding of our customers' needs and processes. We are guided by principles of simplicity, focus, courage and excellence, enabling some of the world's greatest companies to achieve PERFORMANCE MADE SMARTER.